



Carbon fluxes and pelagic ecosystem dynamics near two western Antarctic Peninsula Adélie penguin colonies: an inverse model approach

Sévrine F. Sailley^{1,6,*}, Hugh W. Ducklow², Holly V. Moeller^{1,7}, William R. Fraser³, Oscar M. Schofield⁴, Deborah K. Steinberg⁵, Lori M. Garzio⁵, Scott C. Doney¹

¹Woods Hole Oceanographic Institution, Woods Hole, Massachusetts 02543, USA

²Lamont-Doherty Earth Observatory, Palisades, New York 10964, USA

³Polar Oceans Research Group, PO Box 368, Sheridan, Montana 59749, USA

⁴Institute of Marine and Coastal Sciences, Rutgers University, New Brunswick, New Jersey 08901, USA

⁵Virginia Institute of Marine Science, Gloucester Pt., Virginia 23062, USA

⁶Present address: Plymouth Marine Laboratory, Plymouth, PL13DH, UK

⁷Present address: Stanford University, Stanford, California 09425, USA

ABSTRACT: An inverse food-web model for the western Antarctic Peninsula (WAP) pelagic food web was constrained with data from Palmer Long Term Ecological Research (PAL-LTER) project annual austral summer sampling cruises. Model solutions were generated for 2 regions with Adélie penguin *Pygoscelis adeliae* colonies presenting different population trends (a northern and a southern colony) for a 12 yr period (1995–2006). Counter to the standard paradigm, comparisons of carbon flow through bacteria, microzooplankton, and krill showed that the diatom–krill–top predator food chain is not the dominant pathway for organic carbon exchanges. The food web is more complex, including significant contributions by microzooplankton and the microbial loop. Using both inverse model results and network indices, it appears that in the northern WAP the food web is dominated by the microbial food web, with a temporal trend toward its increasing importance. The dominant pathway for the southern WAP food web varies from year to year, with no detectable temporal trend toward dominance of microzooplankton versus krill. In addition, sensitivity analyses indicated that the northern colony of Adélie penguins, whose population size has been declining over the past 35 yr, appears to have sufficient krill during summer to sustain its basic metabolic needs and rear chicks, suggesting the importance of other processes in regulating the Adélie population decline.

KEY WORDS: Inverse model · Food web · Antarctica · Microzooplankton · Krill · Ecosystem state change · Climate change

INTRODUCTION

Antarctic coastal waters exhibit high rates of primary production (over 2 g C m⁻² d⁻¹ and 100 to 200 g C m⁻² yr⁻¹) during a limited growing season of about 150 to 180 d (Smith et al. 1996, 1998, Smith & Gordon 1997, Arrigo et al. 1998, Vernet et al. 2008). This pri-

mary production supports large standing stocks of top predators (whales, seals, and seabirds; Valiela 1995) with krill as the main trophic link between primary production and top predators (McWhinnie & Denys 1980). This short diatom–krill–top predator food chain is traditionally believed to be the most significant pathway for the pelagic food web in Antarc-

*Email: sesa@pml.ac.uk

tic waters (Hart 1934, Huntley et al. 1991); however, studies have highlighted the importance of microbial processes (bacterial secondary production, microzooplankton grazing) affecting the fate of primary production (Hewes et al. 1985, El Sayed 1988, Daniels et al. 2006). While krill prey mostly on diatoms, microzooplankton are able to prey on smaller size phytoplankton and, like bacteria, are part of the microbial food web. The relative importance of each group of zooplankton (microzooplankton or krill), and the pathways they are linked to, defines the fate of primary production and the food supply for apex predators.

The western Antarctic Peninsula (WAP) region has experienced a rise of 7°C in mean winter air temperature since 1951, making it one of the fastest warming regions on the planet (Smith & Stammerjohn 2001, Vaughan et al. 2003). Along with air temperature rise, the WAP is subjected to increased upwelling of warm Circumpolar Deep Water (Martinson et al. 2008), a related decline of sea-ice extent and seasonal duration (Stammerjohn et al. 2008), a decrease in primary production of about 12% over the WAP in the last 30 yr (Montes-Hugo et al. 2009), a shift in phytoplankton size composition toward smaller cell size (<20 µm; Moline et al. 2008, Montes-Hugo et al. 2009), a decrease in krill abundance in the northern WAP and an increase in prevalence of salps (Atkinson et al. 2004, D. Steinberg unpubl. data), and in some locations, a decline in populations of a top predator, the Adélie penguin *Pygoscelis adeliae* (Ducklow et al. 2007, 2012).

The WAP is the site of the Palmer Long Term Ecological Research (PAL-LTER) project (www.pal.lter.net.edu; Ducklow et al. 2007), with annual austral summer oceanographic cruises in January including routine measurement of primary production, phytoplankton pigments and size fractions, macrozooplankton species abundance and biomass, bacterial biomass and production, and censusing of penguins and other seabirds. The WAP sampling region includes the foraging range of 2 colonies of Adélie penguins, 1 situated near Palmer Station and the second on Avian Island 400 km farther south. The population at the northern colony has decreased sharply over the last 3 decades, from 15 200 breeding pairs in 1975 to 2646 in 2008 (Palmer data, <http://oceaninformatics.ucsd.edu/datazoo/data/pallter/datasets>; Ducklow et al. 2007). The southern Adélie colony is thriving at an estimated 77 515 breeding pairs, and is increasing in size (2012/13 population census; W. Fraser unpubl. data). A change in Adélie diet has also been observed: Adélies from the northern colony went from a

diet of equal parts krill and Antarctic silverfish *Pleuagramma antarcticum* in the early 1970s, the same as Adélies from the southern colony at present, to a diet composed entirely of krill by 1997 (W. Fraser unpubl. data).

While some changes in the components of the food web have been documented, as described above, the rates of exchange between many food-web compartments are not available, thus making it difficult to estimate climate-induced changes in the interactions among food-web compartments. To fill this gap and obtain an objective picture of the food web as a whole, we used the PAL-LTER data set to build and constrain an inverse model for the pelagic food web. The inverse model was used to follow year-to-year changes in the food web (at the time of the cruise) over a 12 yr period, 1995 to 2006, for both the north and south Adélie colonies and foraging areas, totaling 24 inverse model solutions. We chose to separate the north and south colonies, which are experiencing different trends for both Adélie penguins and primary production (Moline et al. 2008, Montes-Hugo et al. 2009). Our working hypothesis was that the northern WAP was impacted earlier by climate change and regional warming than the south; thus it follows that the present state of the southern WAP is similar to that of the northern WAP more than 2 decades earlier (Ducklow et al. 2012). Consequently, the questions that we focused on through this study were (1) What are the differences between the northern and southern food webs? (2) What is the evolution and state of the system through the 12 yr period? (3) What is the importance of krill versus microbial processes? (4) Is the decline of the northern Adélie penguin colony explained by a decline in krill biomass or is the decline linked to other causes (e.g. physical effects, food quality, chick recruitment)?

METHODS

Food web model

We constructed a steady-state inverse model of the WAP pelagic food web based on the earlier models by Ducklow et al. (2006) and Daniels et al. (2006). The inverse model provides a snapshot of the system each January, and the model structure depends on data availability to constrain flows between compartments. As in Ducklow et al. (2006), the inverse model includes small phytoplankton (<20 µm, mostly cryptophytes), large phytoplankton (>20 µm, mostly diatoms), heterotrophic nanoflagellates, microzoo-

plankton, krill *Euphausia superba*, Adélie penguins, Antarctic silverfish, detritus, dissolved organic carbon (DOC), and bacteria, as well as respiration and export processes in addition to exchanges between compartments (e.g. grazing, excretion, egestion). The earlier food web was modified by aggregating heterotrophic nanoflagellates and microzooplankton together (until recently, there were few field data in the PAL-LTER study region for these 2 groups of organisms; Garzio & Steinberg 2013, Garzio et al. 2013) and by the addition of salps. Presence of a silverfish component differs between the northern (silverfish absent from the penguin diet and considered functionally extinct) and southern (silverfish present in the penguin diet) regions. The resulting inverse model is composed of 7 or 8 living compartments (small phytoplankton, large phytoplankton, bacteria, microzooplankton, salps, krill, Adélie penguins, and silverfish in the south) and 2 non-living compartments (detritus and DOC). These 10 (south) or 9 (north) compartments are mass balanced with inflows equaling outflows for each compartment (Table 1). In addition, 4 non-balanced compartments serve as external boundary conditions for the ecosystem. Two of these are the observed primary production for small and large phytoplankton, used to constrain the input to each phytoplankton compartment. The other 2 correspond to respiration and export, the latter containing

inputs from other compartments of carbon that will not be recycled within the pelagic food web. Export includes sinking particle flux, lateral transport, and organic matter that is stored locally (e.g. DOC) and recycled later in the year. The whole system is mass balanced with the inflows from primary production equaling the outflows to respiration and export. Each possible and realistic interaction between compartments is considered (Table 1) and taken into account as a potential flow between compartments. Flows between compartments are constrained to be either a fixed value obtained from observations (e.g. primary production of each phytoplankton group), or between minimum and maximum bounds defined by relationships obtained from the literature (Table 2).

Data

Constraints for some of the inverse model components (e.g. phytoplankton, krill, salps, penguins, bacteria) were obtained using data from PAL-LTER annual survey cruises in each austral summer (January) during the breeding season of Adélie penguins (<http://pal.lternet.edu/data/>, for data and sampling method). Measurements were converted to carbon biomass or fluxes per square meter (integrated over the top 35 m), and averaged over the foraging radius

Table 1. Mass balance relations used in inverse analysis, with flows labeled as 'from-to'; external compartments (ppS, ppL, res, ext) are not mass balanced. DOC: dissolved organic carbon

| Compartment | Abbreviation | Mass balance (inflow = outflow) |
|---|--------------|---|
| Primary production by small phytoplankton | ppS | – |
| Primary production by large phytoplankton | ppL | – |
| Small phytoplankton | phS | $ppS = phS\text{-mic} + phS\text{-salp} + phS\text{-res} + phS\text{-doc} + phS\text{-det} + phS\text{-ext}$ |
| Large phytoplankton | phL | $ppL = phL\text{-mic} + phL\text{-krill} + phL\text{-res} + phL\text{-doc} + phL\text{-det} + phL\text{-ext}$ |
| Bacteria | bac | $doc\text{-bac} = bac\text{-mic} + bac\text{-salp} + bac\text{-res} + bac\text{-doc} + bac\text{-det}$ |
| Microzooplankton | mic | $phS\text{-mic} + phL\text{-mic} + bac\text{-mic} + det\text{-mic} = mic\text{-krill} + mic\text{-res} + mic\text{-doc} + mic\text{-det}$ |
| Salp | salp | $phS\text{-salp} + bac\text{-salp} + det\text{-salp} + mic\text{-salp} = salp\text{-res} + salp\text{-doc} + salp\text{-det} + salp\text{-ext}$ |
| Krill | krill | $phL\text{-krill} + mic\text{-krill} + det\text{-krill} = krill\text{-fish} + krill\text{-pen} + krill\text{-res} + krill\text{-doc} + krill\text{-det} + krill\text{-ext}$ |
| <i>Pleuragramma</i> sp. | fish | $krill\text{-fish} = fish\text{-pen} + fish\text{-res} + fish\text{-doc} + fish\text{-det} + fish\text{-ext}$ |
| Adélie penguins | pen | $krill\text{-pen} + fish\text{-pen} = pen\text{-res} + pen\text{-doc} + pen\text{-det} + pen\text{-ext}$ |
| Detritus | det | $phS\text{-det} + phL\text{-det} + bac\text{-det} + mic\text{-det} + salp\text{-det} + krill\text{-det} + fish\text{-det} + pen\text{-det} = det\text{-mic} + det\text{-krill} + det\text{-salp} + det\text{-doc} + det\text{-ext}$ |
| DOC | doc | $phS\text{-doc} + phL\text{-doc} + bac\text{-doc} + mic\text{-doc} + salp\text{-doc} + krill\text{-doc} + fish\text{-doc} + pen\text{-doc} + det\text{-doc} = doc\text{-bac} + doc\text{-ext}$ |
| Respiration | res | – |
| Export | ext | – |

Table 2. Minimum and maximum constraints for flow between compartments; all flows are scaled in $\text{mmol C m}^{-2} \text{d}^{-1}$. Bacteria abundance in mmol C m^{-2} ; body mass: average mass of 1 organism in mmol C ; average length: length of 1 organism in mm ; foraging area in m^2 ; daily ration: amount of C ingested in 1 d including all food sources; salp and krill abundance: number of ind. m^{-2} over the foraging area; salp and krill biomass: mmol C m^{-2} over the foraging area (upper 120 m of the water column). DOC (POC): dissolved (particulate) organic carbon; pHs: small phytoplankton; pHL: large phytoplankton

| Compartment | Flow | Lower bound | Higher bound | Source |
|-------------------------|---------------------------------------|--|--|--|
| Small phytoplankton | Respiration | 5 % primary production ^a | 30 % primary production ^a | Ducklow et al. (2006) |
| | To DOC | 1 % primary production ^a | 20 % primary production ^a | H. Ducklow pers. obs.. |
| Large phytoplankton | Flow to detritus and export | 2 % chl <i>a</i> concentration ^a | 5 % chl <i>a</i> concentration ^a | Anadon et al. (2002) |
| | Respiration | 5 % primary production ^a | 30 % primary production ^a | Ducklow et al. (2006) |
| | To DOC | 1 % primary production ^a | 20 % primary production ^a | H. Ducklow pers. obs.. |
| | Flow to detritus and export | 2 % chl <i>a</i> concentration ^a | 5 % chl <i>a</i> concentration ^a | Anadon et al. (2002) |
| Bacteria | Ingestion of DOC | – | Abundance ^a × 3.5 × (body mass) ^{-0.25} | Moloney & Field (1989) |
| | Respiration | 20 % ingested DOC | Abundance ^a × 1.7 × (body mass) ^{-0.25} | Moloney & Field (1989) |
| Microzooplankton | Net production efficiency | 50 % ingested DOC | 95 % ingested DOC | Daniels et al. (2006) |
| | Ingestion of pHs | – | 70 % primary production by pHs ^a | Garzio et al. (2013) |
| | Ingestion of pHL | – | 30 % primary production by pHL ^a | Garzio et al. (2013) |
| | Respiration | 20 % carbon intake | 90 % carbon intake | Daniels et al. (2006) |
| | To detritus | 10 % carbon intake | 50 % carbon intake | Daniels et al. (2006) |
| | to DOC | 10 % carbon intake | 100 % carbon intake | Daniels et al. (2006) |
| Salp | Ingestion | Abundance ^a × exp(3.85 × log (average length ^a) – 3.724) ^b | 50 % primary production ^a | Perissinotto et al. (1997), Ross et al. (1998) |
| | Respiration | 2 % salp body mass | Abundance ^a × exp(69.14 × (body mass) ^{0.78}) ^b | Alcaraz et al. (1998), Iguchi & Ikeda (2004) |
| Krill | To detritus | 22 % carbon intake | 56 % carbon intake | Pakhomov et al. (2002), Phillips et al. (2009) |
| | To DOC | 10 % carbon intake | 100 % carbon intake | Daniels et al. (2006) |
| | Daily ration | 5 % krill biomass ^a | 25 % krill biomass ^a | Perissinotto et al. (1997) |
| | Grazing on phytoplankton | 5 % krill biomass ^a | 50 % primary production ^a | Perissinotto et al. (1997) |
| | Grazing on microzooplankton | 20 % daily ration | 80 % daily ration | Perissinotto et al. (1997) |
| | Respiration | Abundance ^a × exp (0.275 + 0.814 × log (body mass)) ^c | 5 % krill biomass ^a | Ikeda & Mitchell (1982), Le Fevre et al. (1998) |
| | Flow to detritus and export | 0.75 % krill biomass ^a | 1.3 % krill biomass ^a | Ikeda & Mitchell (1982) |
| | To DOC | 10 % carbon intake | 100 % respiration | Daniels et al. (2006) |
| | Flow to predator, detritus and export | 0.84 % krill biomass ^a | – | Shreeve et al. (2005) |
| | Respiration | 20 % carbon intake | 90 % carbon intake | Daniels et al. (2006) |
| <i>Pleurogramma</i> sp. | To detritus | 10 % carbon intake | 50 % carbon intake | Daniels et al. (2006) |
| | To DOC | 10 % carbon intake | 100 % respiration | Daniels et al. (2006) |
| | Total loss | 60 % carbon intake | 90 % carbon intake | Daniels et al. (2006) |
| | Daily ration | 1.4 × (n Adélie ^a /foraging area ^a) × krill C conversion ^{a,d} | 1.6 × (n Adélie ^a /foraging area ^a) × krill C conversion ^{a,d} | Chappell et al. (1993) |
| Adélie penguins | Respiration | 20 % carbon intake | – | Daniels et al. (2006) |
| | To detritus | 10 % carbon intake | 50 % carbon intake | Daniels et al. (2006) |
| | To DOC | 10 % carbon intake | 100 % respiration | Daniels et al. (2006) |
| Export | POC flux | 10 % primary production ^a | 50 % primary production ^a | Daniels et al. (2006) |
| | DOC flux | – | 10 % primary production ^a | Daniels et al. (2006) |

^aDenotes data-based values; ^bFiltration rate in ml h^{-1} ; ^cOxygen uptake in $\text{mmol O}_2 \text{ind.}^{-1} \text{h}^{-1}$; ^dCalculated from data

of the Adélie penguin colonies. Phytoplankton were constrained with measured primary production and chlorophyll concentration integrated over the upper 35 m to include the entire euphotic zone and deep chlorophyll maximum (Fig. 1a,b). Assuming, for each sampling period, that size-fractionated primary production is proportional to size-fractionated chlorophyll *a* (chl *a*) concentration, we divided primary production into large (>20 μm) and small (0.4–20 μm) phytoplankton pools. For years without a size fraction determined through chl *a* filtration (1995 to

1998), we used HPLC pigment data processed through ChemTax (Wright & Van den Enden 2000) to determine the diatom fraction in the phytoplankton. We assumed that the large fraction is composed entirely of diatoms. There are fewer HPLC measurements than chl *a* filtration data in terms of stations sampled, and the record is not continuous (missing 2 years in South WAP, 1 year in North WAP). In addition, there is a disparity in size fraction and total chl *a* between HPLC and filtration: there is no bias, but a year-to-year variation of inconsistent ampli-

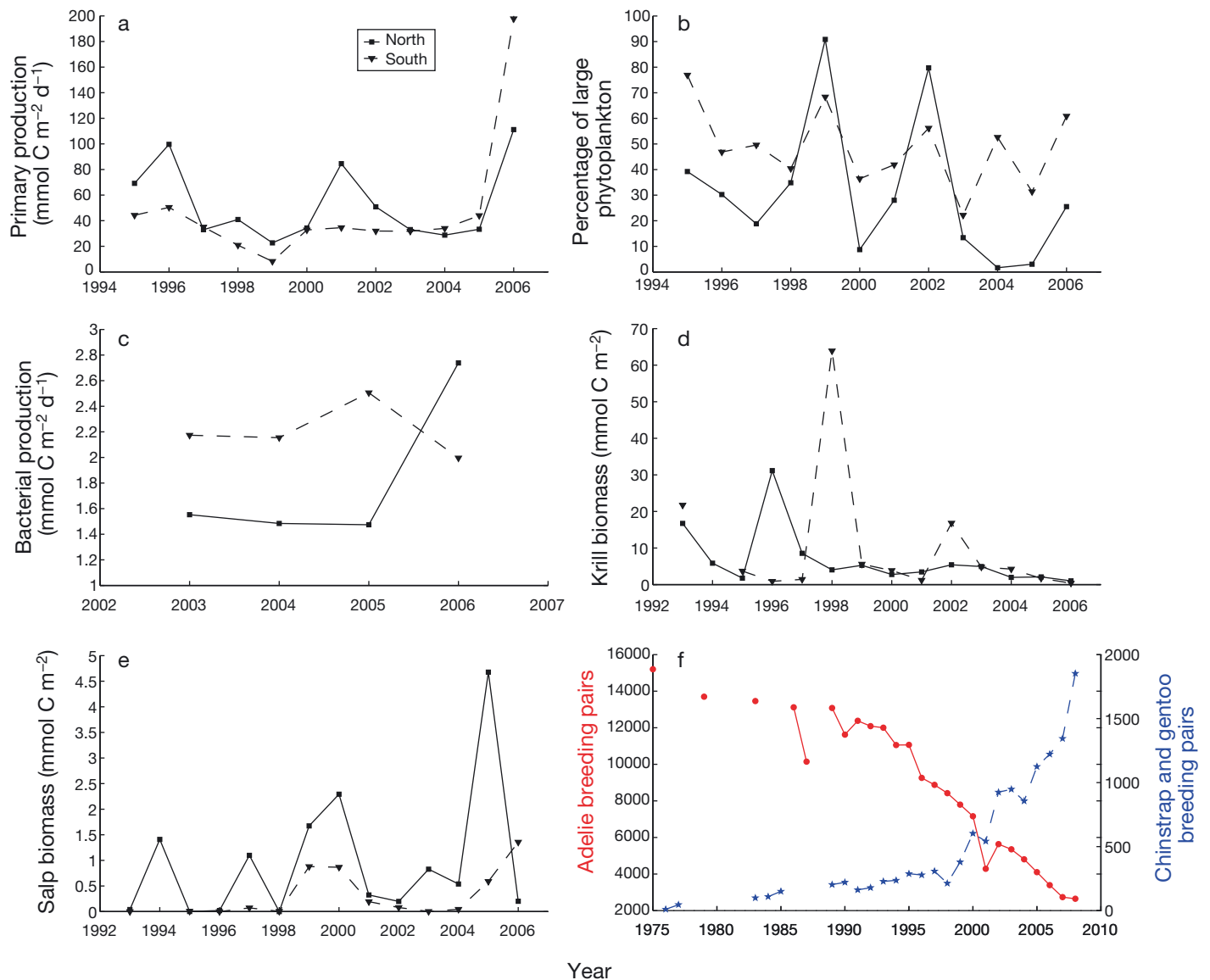

Fig. 1. Input data from observations for (a) primary production, (b) percentage of primary production due to large phytoplankton, (c) bacterial production, (d) krill biomass, (e) salp biomass, and (f) penguin breeding pairs at Palmer Station including Adélie (solid line with dots) and chinstrap plus gentoo penguins (dashed line with stars). Data are shown for both the North (solid line with squares) and South western Antarctic Peninsula (dashed line with inverse black triangles). Note the different time scales (x-axis) for different panels

tude. Thus HPLC was not used for all size fraction determinations.

Krill and salp abundance data (Fig. 1d,e) are from trawls taken in the upper 120 m of the water column (but integrated to 0–35 m for this analysis). Abundances were converted to carbon biomass using relationships found in the literature (krill: Morris et al. 1988, Siegel 1992 for abundance to wet weight conversion, Pakhomov et al. 2002 for wet weight to dry and carbon weight conversions; salps: Huntley et al. 1989, Phillips et al. 2009 for abundance to wet weight conversion, and Pakhomov et al. 2002 for wet weight to dry and carbon weight conversions). Penguin population size (Fig. 1f) is from the number of breeding pairs, counted annually for the northern colony (<http://pal.lternet.edu/data/>) and for the southern colony estimated using aerial photography to establish baselines and annual ground censuses of reference colonies to determine trends. Bacterial abundance and productivity (measured with the leucine incorporation technique; Fig. 1e) integrated to 35 m were also used. Data on bacteria are only available from 2002 onward (Fig. 1c); average bacterial biomass and productivity values were used as constraints for the years without data (1995–2001). Comparing solutions using bacterial constraints from averaged data versus yearly data showed changes of less than 10% for flow through bacteria, and 5% or less for flow through other compartments. In addition, constraints for respiration and ingestion of DOC by bacteria were loose (2 orders of magnitude difference between minimal and maximal constraints), allowing the use of averaged biomass and production to determine constraints for years with and without data.

Finally, dilution experiments to measure microzooplankton grazing in 2010 to 2011 showed that grazing of microzooplankton grazers removes 32 to 63% d^{-1} of total primary production, and 61 to 71% of small phytoplankton (nano- and pico-) primary production at Palmer Station (Table 2 in Garzio et al. 2013). We constrained the inverse model flow from phytoplankton to microzooplankton to reflect their 'preference' for smaller phytoplankton by constraining ingestion as a percentage of primary production by each size class. The use of a percentage constraint provides for flexibility in the flows, allowing for possible covariation of microzooplankton biomass and phytoplankton production (see Table 2 for the constraints on ingestion). Additionally, the data on biomass and abundance of microzooplankton collected at the same time (Garzio & Steinberg 2013) were used with an allometric relationship (Moloney &

Field 1989) to obtain constraints for the flows through microzooplankton. We then compared the flows for constraints based on the allometric relationship or 'food preference.' No significant differences were found between the 2 approaches. We chose to use the latter for the reason mentioned above (covariation of microzooplankton with phytoplankton). If we did not use constraints on microzooplankton ingestion (i.e. only on respiration and excretion), flows from large phytoplankton to microzooplankton were overly important compared to flows to krill. With constraints on microzooplankton ingestion, the flows of large phytoplankton to microzooplankton and krill were closer to the expected flows within the Antarctic food web. The inverse model was applied to North and South WAP areas for the 1995 to 2006 time period. North and South WAP were defined by the Adélie colonies at Anvers (north) or Avian (south) Islands, including nearby hydrographic stations on the lines from the sampling grid (600 and 200, respectively; Waters & Smith 1992). As such, the designations 'North WAP' and 'South WAP' refer to their position relative to each other and on the sampling grid, not to their overall geographic position.

In the model run, unless otherwise indicated, top predators were Adélie penguins. The attachment of Adélie penguins to a nest facilitates their individual count, providing annual absolute abundances. Other krill predators (e.g. fur seal, crabeater seal, whales) or Adélie predators (e.g. leopard seal, killer whales) are not subjected to a regular census. Other predator censuses do not provide absolute measures of their abundance, only trends in their populations for the region.

Inverse model solution

Another difference from the inverse models of Ducklow et al. (2006) and Daniels et al. (2006) is the method used to solve the food web and obtain flow values. Mathematically, linear inverse problems can be written in matrix notation as (Glover et al. 2011):

$$\mathbf{A} \times \mathbf{x} \approx \mathbf{b} \quad (1)$$

$$\mathbf{E} \times \mathbf{x} = \mathbf{f} \quad (2)$$

$$\mathbf{G} \times \mathbf{x} \geq \mathbf{h} \quad (3)$$

where \mathbf{x} is a vector containing all of the unknown flows of carbon between compartments. \mathbf{A} is a matrix of the topological food web, \mathbf{b} gives the mass conservation relationships (equalities that have to be met approximately), \mathbf{E} includes site-specific meas-

urements so \mathbf{f} is a vector of site-specific constraints that have to be met (equalities that have to be met exactly, e.g. primary production), and \mathbf{G} contains physiological constraints so that \mathbf{h} puts bounds on flows and defines relationships between flows (inequalities or bounds on flows). Often the problem originally only contains the latter 2 types of equations (Eqs. 2 & 3), and the approximate equalities (Eq. 1) are added to single out 1 solution.

Quadratic and linear programming methods are the main mathematical techniques used to solve the vector \mathbf{x} in this type of model. Ducklow et al. (2006) and Daniels et al. (2006) solved the inverse model with a least-squares approach in Matlab. We implemented the inverse model in R (LIM package, Xranges function, Soetaert et al. 2009), giving us a new set of tools to solve the set of linear equations. Depending on the active set of equalities (Eq. 2) and constraints (Eq. 3), the system is either under-determined, evenly determined, or over-determined. Solving these problems depends on how the model is determined and the size of the solution space (Glover et al. 2011):

If the model is evenly determined, there is only 1 solution that satisfies the equations exactly. This solution can be singled out by matrix inversion or using the least squares method.

If the model is over-determined, there is only 1 solution in the least squares sense; this solution is singled out (least squares with equalities and inequalities). This can also return the parameter covariance matrix, which gives an indication of the confidence intervals and relationships among the estimated unknowns (elements in \mathbf{x}).

If the model is under-determined, an infinite number of solutions exists. To solve such models, there are several options: (1) finding the 'least distance' or parsimonious solution, i.e. the solution with minimal sum of squared unknown path lengths between compartments; (2) estimating value ranges by successively maximizing and minimizing each unknown in turn (Monte Carlo); the mean of all results is then a model solution; or (3) randomly sampling the solution space using a Markov chain. This third method returns the marginal probability density function for each unknown (Van den Meersche et al. 2009).

The WAP inverse model is composed of 48 flows (unknowns), 11 of which are unconstrained, 33 of which are constrained by inequalities (some including more than 1 flow), and 2 of which are constrained by equalities (primary production), making it overall an under-determined inverse model. The parsimonious solution (1) used by Ducklow et al. (2006) and

Daniels et al. (2006) has a tendency to maximize or minimize the values of intercompartmental flows, particularly for microbial flows (Stukel & Landry 2010, Stukel et al. 2012), and was set aside as less desirable. We used the Monte Carlo approach (2) as it gives us an average value for the flows within the range of valid solutions as well as the uncertainties on flow values (note that uncertainties are only presented for key results, and where it would not impede figure comprehension). We did not use the random sampling method (3) as the obtained flow values were not significantly different from the Monte Carlo approach, and the method seemed to create correlation between flow values.

Network indices

To gain insight on major food web processes such as the fate of primary production, system-level network indices (Legendre & Rassoulzadegan 1996) were used to compare food-web states from inverse model solutions. The network indices described 3 major pathways for carbon flow through a food web (Fig. 2): the sinking and export of ungrazed phytoplankton, food-web transfer to upper trophic levels, and recycling through the microbial loop. These 3 pathways are related to the phytoplankton size structure and matching (synchronization) of phytoplankton production with grazing. Legendre & Rassoulzadegan (1996) derived analytical solutions for the proportion of the primary production allocated to each of the 3 pathways based on the ratio of large phytoplankton primary production (PI) to

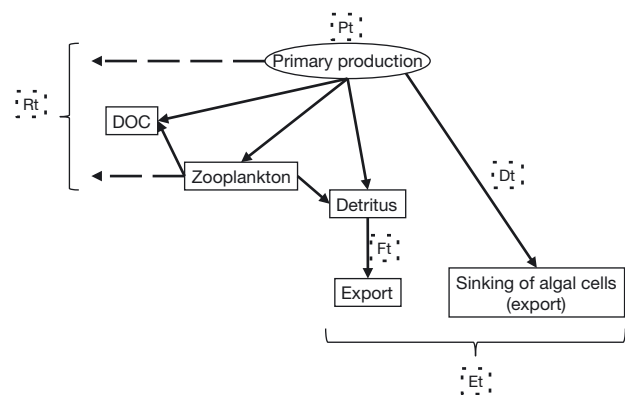

Fig. 2. Pathways for primary production, based on Legendre & Rassoulzadegan (1996). Pt: total primary production; Rt: recycled material; Dt: sinking of ungrazed phytoplankton cells; Ft: export due to transfer through the food web; Et: total export; DOC: dissolved organic carbon. Note that this is not a representation of the western Antarctic Peninsula food web

total primary production (Pt), Pl/Pt, and 4 other indices: Rt/Pt, the ratio of recycling to total primary production; Ft/Pt, the ratio of export due to food web transfer to higher trophic levels; Dt/Pt, the ratio of export of intact algal cells; and Et/Pt, the ratio between export and total production (Fig. 2). The values for Pt, Rt, Ft, Dt, and Et are related through $Et = Ft + Dt$ and $Pt = Rt + Et$. The food-web transfer term, Ft, includes any carbon passed up the food chain that is then exported out of the surface ocean; this includes sinking fecal pellets (export of detritus) and export production of mesozooplankton or krill (e.g. sinking carcasses). Dt is the fraction of ungrazed, sinking phytoplankton; in the inverse model, it is the amount of phytoplankton directly exported. The recycling pathway Rt was found by subtracting the total export (Et) from the total net primary production (Pt). The Rt term is equal to the sum of flows going to respiration directly and the DOC produced. Et/Pt is conceptually equivalent to the e- or f-ratio commonly used in oceanography (Eppley & Peterson 1979). Note that in our case, Pl and Pt are not obtained from the inverse model flow value but from the data. The ratio of primary production by large phytoplankton to total phytoplankton helps define the fate of primary production carbon. This is because small phytoplankton cells are more likely to become a part of the microbial loop than large phytoplankton. Thus it can be defined as a network index, and we kept the definition from Legendre & Rassoulzadegan (1996).

Legendre & Rassoulzadegan (1996) used values from the literature to estimate the magnitude of these pathways for 5 different types of food webs, including a polar one. The pathways ranged along a continuum of decreasing export to primary production (e-) ratios. At one extreme is the sinking of ungrazed phytoplankton, representing a food web with high primary production that is not matched by grazing. At the other extreme is the microbial loop, an almost closed system with near 0 export of primary production, consisting of bacteria and protozoans. Between the 2 extremes in order of decreasing export/primary production are the herbivorous, multivorous, and microbial food webs. The separation between the 3 food webs (Fig. 2) depends primarily on the partitioning of phytoplankton size fractions. A food web with a phytoplankton assemblage dominated by larger cells (diatoms) will have predominantly large zooplankton (e.g. meso- and or macrozooplankton, such as krill in the WAP) and high export through fecal pellets. This is

the herbivorous food web with high Pl/Pt, Ft/Pt, and Et/Pt (Table 3). In a food web with a phytoplankton assemblage dominated by smaller cells, the predominant grazer will be microzooplankton, leading to a lower export rate, as their smaller fecal pellets sink more slowly and are more subject to remineralization. This is the microbial food web with low Pl/Pt, Ft/Pt, and high Rt/Pt (Table 3). The multivorous food web is situated between the herbivorous and microbial food webs, with more balanced importance of respiration and export. The food webs and pathways obtained with the network indices provide a baseline to compare the North and South WAP inverse model solutions in austral summer through the 12 yr period.

RESULTS

North and South WAP

In both the North and South WAP, the observations used to constrain the inverse model (Fig. 1) exhibited high interannual variability. The interannual variability makes a direct comparison between the North and South WAP for any particular year difficult. Instead, data for the 12 yr period were averaged and used to constrain what can be referred to as an average food web for each region. There was a relatively greater abundance of large phytoplankton in the South WAP, but overall the smaller size fraction of phytoplankton tended to contribute substantially to primary production in both regions (on average 69% in the North WAP and 52% in the South WAP). In the North WAP, the large and small phytoplankton, microzooplankton, krill, and DOC compartments all had throughputs ranging from 8 to 35 mmol C m⁻² d⁻¹ (Fig. 3a). In the South WAP, believed to be less im-

Table 3. Network index values for specific pathways, after Legendre & Rassoulzadegan (1996). Pl/Pt: ratio of primary production by large cells to total primary production; Rt/Pt: ratio of recycling to total primary production; Ft/Pt: ratio of export due to transfer through the food web to total primary production; Dt/Pt: ratio of sinking of ungrazed phytoplankton cells to total primary production; Et/Pt: ratio of total export to total primary production (see Fig. 2 for index and food web)

| Pathway | Index values | | | | |
|---------------------------|--------------|-------|-------|-------|-------|
| | Pl/Pt | Rt/Pt | Ft/Pt | Dt/Pt | Et/Pt |
| Sinking of ungrazed cells | 1 | 0 | 0 | 1 | 1 |
| Herbivorous food web | 0.8 | 0.3 | 0.6 | 0.1 | 0.7 |
| Multivorous food web | 0.35 | 0.6 | 0.3 | 0.1 | 0.4 |
| Microbial food web | 0.1 | 0.8 | 0.2 | 0 | 0.2 |
| Microbial loop | 0 | 1 | 0 | 0 | 0 |

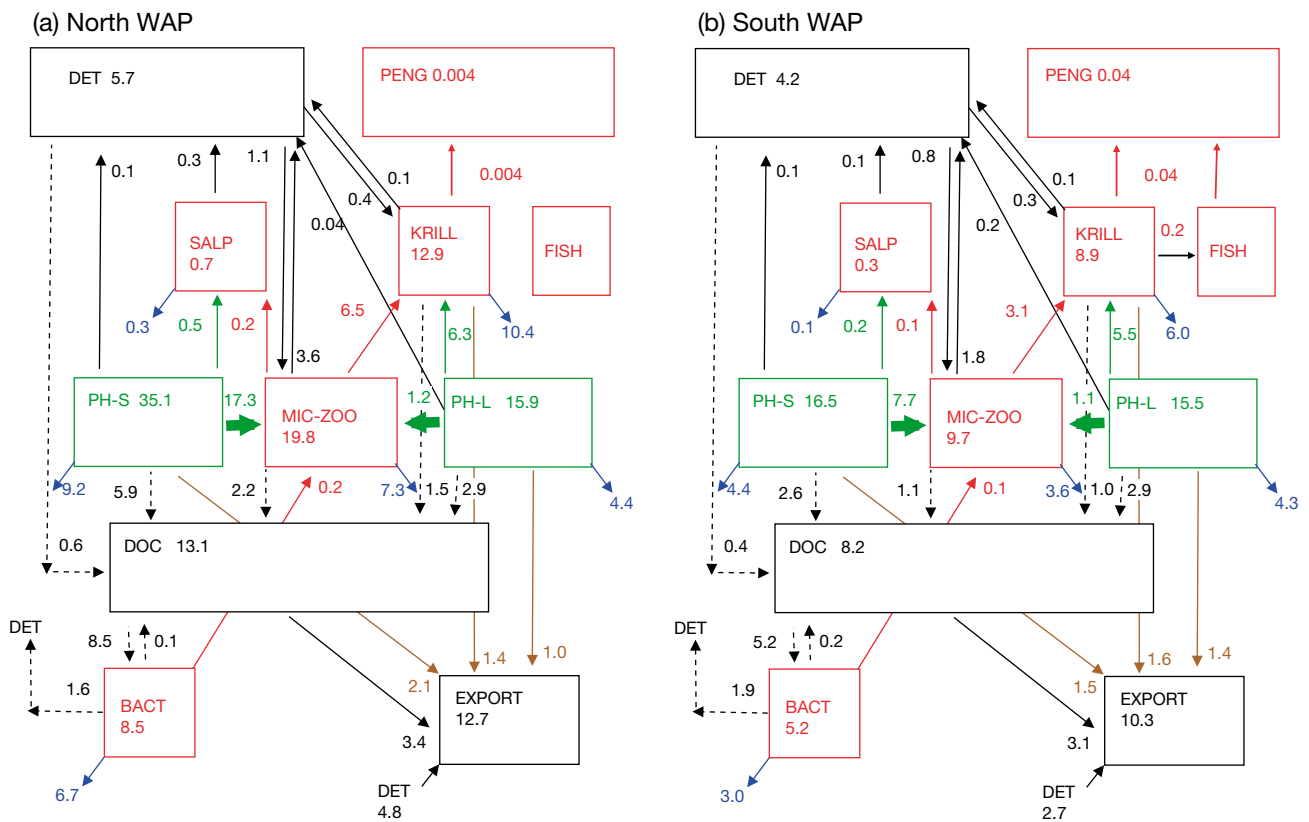

Fig. 3. Monte Carlo central value flows ($\text{mmol C m}^{-2} \text{d}^{-1}$) for the (a) North and (b) South western Antarctic Peninsula (WAP) food webs. Flows $<0.1 \text{ mmol C m}^{-2} \text{d}^{-1}$ are omitted for clarity, except the krill–fish–penguin ingestion values. Flows initiated by small (large) phytoplankton are on the left (right). Flows initiated by herbivores are in the top half of the diagram, and the microbial loop and export underneath. Microzooplankton are placed in the center to emphasize their importance in mediating flows in this ecosystem. The numbers in the compartments are the total steady-state throughputs (sum of all inputs, $\text{mmol C m}^{-2} \text{d}^{-1}$). Flow categories are indicated by color: black: dissolved organic carbon (dashed lines) and detrital (solid lines) flows; green: herbivory; red: secondary and higher-order consumers; blue: respiration. Abbreviations for compartments (left to right and top to bottom): DET: detritus; PENG: Adélie penguin; SALP: salp; KRILL: krill; FISH: Antarctic silverfish; PH-S: small phytoplankton; MIC-ZOO: microzooplankton; PH-L: large phytoplankton; DOC: dissolved organic carbon; BACT: bacteria; EXPORT: export

pacted by regional warming and more characteristic of Antarctic food webs (Ducklow et al. 2007), the large and small phytoplankton, microzooplankton, krill, and DOC compartments all had throughputs ranging from 8 to 16 $\text{mmol C m}^{-2} \text{d}^{-1}$ (Fig. 3b). For both regions, the largest intercompartmental flow was ingestion of small phytoplankton by microzooplankton (mean \pm SD = 17.7 ± 3.8 and $7.7 \pm 1.9 \text{ mmol C m}^{-2} \text{d}^{-1}$ in the North and South, respectively; Fig. 3), followed by krill ingestion of large phytoplankton (diatoms, 6.3 ± 2.9 and $5.5 \pm 2.6 \text{ mmol C m}^{-2} \text{d}^{-1}$ in the North and South; Fig. 3) and bacterial uptake of DOC (8.5 ± 5.6 and $5.2 \pm 3.5 \text{ mmol C m}^{-2} \text{d}^{-1}$ in the North and South; Fig. 3).

In the North WAP, the higher biomass of small phytoplankton on average led to larger ingestion of total primary production flows for microzooplankton

compared to krill: 38 versus 26%, respectively. In the South WAP, inflows through microzooplankton and krill were more even: 30 versus 28%, respectively (Fig. 3). Importantly, the solutions satisfy the metabolic requirements of krill and penguins in both regions. There was greater carbon flow through salps in the north, with an ingestion of small phytoplankton by salps of $0.5 \text{ mmol C m}^{-2} \text{d}^{-1}$ in the North WAP compared to $0.2 \text{ mmol C m}^{-2} \text{d}^{-1}$ in the South WAP (Fig. 3). For comparison, flow from small phytoplankton to microzooplankton was 17.3 and $7.7 \text{ mmol C m}^{-2} \text{d}^{-1}$ in the North and South WAP, respectively (Fig. 3). Unless there was a salp bloom event (e.g. North WAP in 2005; Fig. 1e), flows through salps, penguins, and fish accounted for less than 1% of primary production individually and less than 2% of primary production when added together. Flows

through bacteria, microzooplankton, and krill accounted for most of the primary production (60 to 80%); the rest goes to phytoplankton respiration, DOC excretion, detritus, and export through sinking of ungrazed cells. Part of the DOC produced was used by bacteria, and part of the detritus was grazed by microzooplankton, salps, and krill.

Ingestion depends on both the biomass of the grazer (minimum bound) and the predation pressure it is under. Respiration reflects the metabolism of the organism and depends on the organism biomass (minimum bound) and/or total ingestion (maximum bound). Comparison of inflow and outflow, normalized to total primary production, denotes the importance of the organism for the food web as a pathway for primary production. We made this comparison annually for the 1995 to 2006 time period, to determine any long-term change. Flows (ingestion and respiration) through bacteria, microzooplankton, and krill were normalized to primary production and examined for possible trends (Fig. 4). Note that although krill ingest microzooplankton, this flow of carbon amounts to a maximum of 10% of the primary production being directed to krill through microzooplankton, or less than half of microzooplankton total ingestion, allowing one to consider separately the roles of microzooplankton and krill within the food web.

On average, normalized flows through microzooplankton, bacteria and krill were roughly comparable (Table 4) with those through microzooplankton somewhat more important. In the North WAP, microzooplankton ingestion accounted for 32% of the primary production versus 20% for the krill. These values were 22 and 20% in the South WAP (Table 4), suggesting different flows through the system between the North and South. In the South, normalized ingestion and respiration flows varied with time around an average value for all organisms (Fig. 4). Normalized ingestion of microzooplankton was slightly higher than that of krill, and normalized krill respiration

Table 4. Mean \pm SD of model-derived yearly respiration and total ingestion as a percentage of yearly total primary production for bacteria, microzooplankton and krill in the North and South western Antarctic Peninsula

| | South | North |
|------------------|----------------|-----------------|
| Ingestion | | |
| Bacteria | 16.6 \pm 9.9 | 12.8 \pm 3.7 |
| Microzooplankton | 22.3 \pm 6.9 | 32.1 \pm 10.8 |
| Krill | 20.2 \pm 7.7 | 20.0 \pm 6.1 |
| Respiration | | |
| Bacteria | 8.5 \pm 4.4 | 8.6 \pm 3.2 |
| Microzooplankton | 8.0 \pm 2.7 | 11.7 \pm 4.2 |
| Krill | 16.0 \pm 7.8 | 16.4 \pm 5.2 |

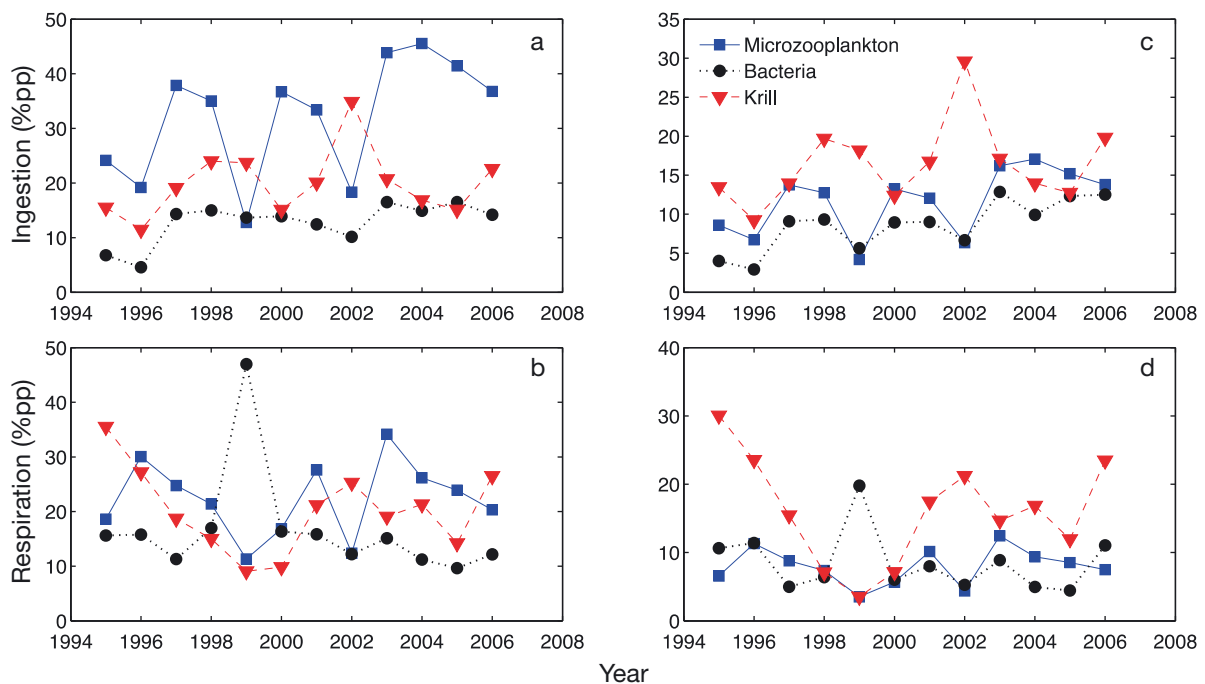

Fig. 4. Yearly (a,c) ingestion and (b,d) respiration as a percentage of primary production (%pp) in the North (a,b) and South (c,d) western Antarctic Peninsula for bacteria (black dashed line with circles), microzooplankton (blue line with squares), and krill (red dashed line with triangles)

piration was slightly higher than that of microzooplankton. Tendencies for high or low flow values covary among bacteria, microzooplankton, and krill. The unusual values in 1999 were due to the fact that it was a year with low primary production dominated by small phytoplankton resulting in higher DOC levels and bacterial production. Overall, there was no substantial trend over the 12 yr period in the South WAP.

In the North WAP, the normalized ingestion of carbon by microzooplankton was usually higher, up to twice that ingested by krill and bacteria (Fig. 4). Exceptions were 1995, 1996, 1999, and 2002; krill biomass was high in 1996, and in the other 3 years, the phytoplankton assemblage was dominated by the large size fraction, resulting in higher carbon flows through krill. There was a trend toward increasing normalized flows through bacteria (ingestion and respiration, Fig. 4a,b), especially the normalized respiration that tripled between 1995–1996 and 2003–2006. At the same time (2000–2006), the normalized ingestion by bacteria approached that of krill. Additionally, in the North WAP, there was an apparent inverse correlation of flow through krill versus through bacteria and microzooplankton from 2000 onward. Normalized ingestion and respiration of bacteria and microzooplankton exhibited high values when those of krill were low. This can be related to decreased summer primary production near Palmer Station, from 99 to 22 mmol C m⁻² d⁻¹ between 1996 and 1999 (Fig. 1a). Similarly, the increase in normalized bacterial flows can be related to the relative decrease in large phytoplankton from 40% in 1995–1999 to 20% in 2000–2006. This resulted in an increase in flows through the DOC pool due to release by small phytoplankton; the small phytoplankton to DOC flow for the average constraints solution was 5.9 and 2.6 mmol C m⁻² d⁻¹ in the North and South WAP, respectively (Fig. 3), illustrating regional differences in the source and fate of the DOC.

Ecosystem indices

The relative importance of the microbial food web (bacteria and microzooplankton) versus the diatom–krill–apex predator food chain over time (1995–2006) can be explored with network indices. According to Fig. 2 and Legendre & Rassoulzadegan (1996), a pelagic food web dominated by the diatom–krill–apex predator food chain would be a herbivorous food web, with phytoplankton dominated by large

diatoms (PI/Pt > 0.8), less recycling (Rt/Pt < 0.6), an efficient transfer of primary production toward higher levels (Ft/Pt > 0.6), and high export of ungrazed primary production or fecal pellets (Et/Pt > 0.7 and Dt/Pt > 0.1). Note that the choice of constraint for microzooplankton ingestion did not affect ecosystem indices values.

Note that since PI/Pt directly reflects observational constraints, it does not have a model-derived uncertainty as its value does not depend on the inverse model results, contrary to the other indices. For all other network indices, the large uncertainties for indices that fall within the multivorous range reflects the variety of fates for primary production carbon compared to the more straightforward bacterial or herbivorous food web.

The first index (PI/Pt; Fig. 5) was constrained by size fraction and pigment observations (Fig. 1b). There was substantial interannual variation in the index value: 0.02 to 0.91 in the north and 0.22 to 0.77 in the South, with average values of 0.31 and 0.49, respectively. Average PI/Pt in the North increased in years of high diatom fraction (1999 and 2002, over 80% of diatoms), but for most years, PI/Pt was below 0.4 (0.35 being the value for a multivorous food web). The PI/Pt value in the North decreased over time with the indices switching from defining a herbivorous–multivorous food web toward defining a more microbial food web. Interannual variation in the South was less pronounced. PI/Pt values for the South stayed in a range characteristic of a herbivorous–multivorous food web, except for 2003 and 2005 when PI/Pt values indicated a multivorous–microbial food web.

The recycling index, Rt/Pt, derived from the inverse model flows, showed interannual variation;

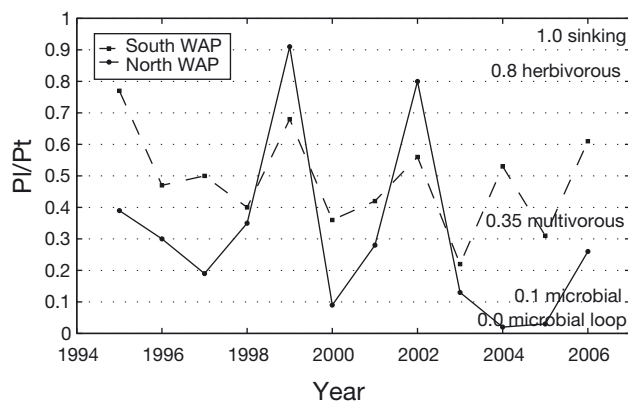

Fig. 5. Yearly ratio of large phytoplankton production (PI) to total phytoplankton production (Pt) and PI/Pt network indices for the North (solid line with dots) and South (dashed line with squares) western Antarctic Peninsula (WAP)

however, the variability was not as large as Pl/Pt (Fig. 6). In the North, Rt/Pt varied from 0.55 to 0.83 with an average of 0.73, while in the South, Rt/Pt varied from 0.55 to 0.83 with an average of 0.67. The North Rt/Pt increased with time (R^2 of 0.6) from approximately 0.6 in 1995–1996 to around 0.8 by 2006, indicating a transition from a multivorous to a microbial food web (Table 3) as the dominant pathway for primary production. South Rt/Pt values indicated a multivorous–microbial food web except for 1995 and 1996, when values were between the microbial food web and microbial loop. Overall, South Rt/Pt did not show any trend with time.

The food web transfer index Ft/Pt (results not shown) was very low (<0.15 for both North and South). This low Ft/Pt described either a microbial loop or sinking of ungrazed primary production (Table 3). The fourth index, Dt/Pt , reflecting production of detritus (results not shown) varied between 0.1 and 0.45 in both the North and South, with an average of 0.19 and 0.28, respectively. North Dt/Pt values exhibited a decreasing trend to 0.1 or below (value of 0.09 in 2003, R^2 of 0.6), indicating a herbivorous–multivorous food web with a trend toward a dominant microbial pathway. South Dt/Pt values indicated a herbivorous–multivorous food web without any trend.

The export index Et/Pt gives additional information on what processes govern the food web (Table 3, Fig. 7). North Et/Pt was highest in 1995 and 1996 (0.38 and 0.45, respectively), consistent with a multivorous food web; however, from 1999 to 2002, Et/Pt indicated a microbial food web. For 2002 to 2006, Et/Pt was variable and indicated a system oscillating between a microbial food web and a dominant microbial loop. In the South, 1995 and 1996 had Et/Pt

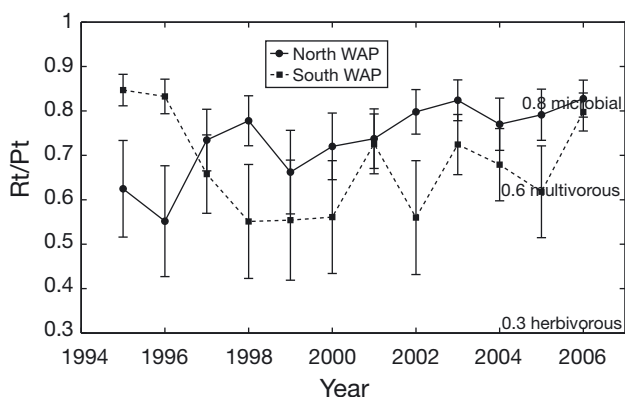

Fig. 6. Yearly ratio of recycled carbon (Rt) to total primary production (Pt) and Rt/Pt network indices for the North (solid line with dots) and South (dashed line with squares) western Antarctic Peninsula (WAP). With standard deviation

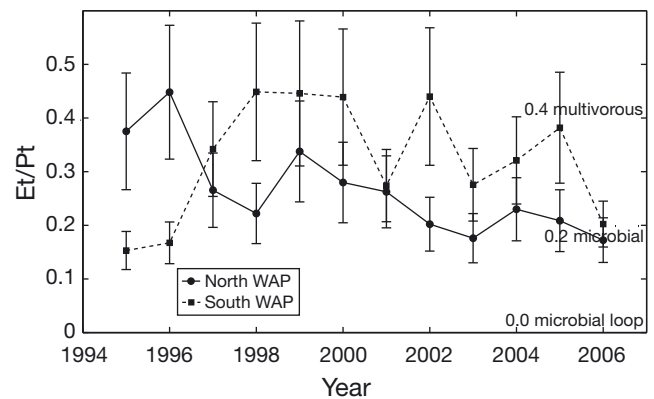

Fig. 7. Yearly ratio of export (Et) to total primary production (Pt) and Et/Pt network indices for the North (solid line with dots) and South (dashed line with squares) western Antarctic Peninsula (WAP). With standard deviation. Note that the value and variation for the exported primary production to total primary production ratio (Dt/Pt) are similar and follow the same variations as Et/Pt

values below 0.1, indicating that almost all of the primary production carbon was recycled. The years 2001, 2003, and 2006 all had values around 0.3, indicating a microbial food web. Et/Pt values in other years varied around 0.40 for a multivorous–herbivorous food web.

The individual ecosystem indices can be combined to characterize the food-web state (Fig. 8). Individually, each index gave information on where a specific process places the food web in terms of herbivorous versus microbial processes (Table 3). When the indexes are really close to the value for one pathway, this is the state of the system. If the indexes fall in between 2 values, then it indicates a system with

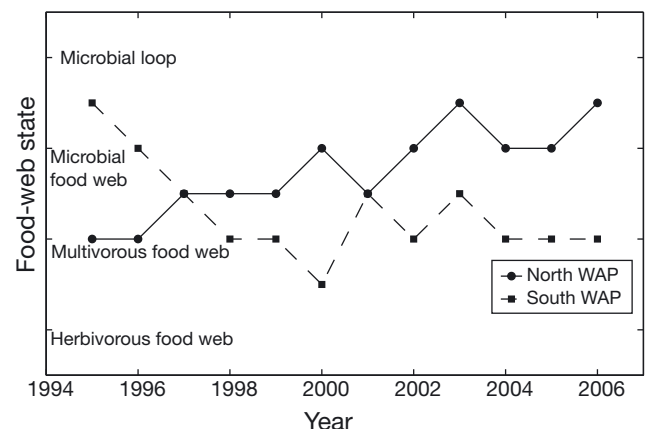

Fig. 8. Annual predominant food-web state as indicated by network indices for the North (solid line with dots) and South (dashed line with squares) western Antarctic Peninsula (WAP)

mixed pathways. The evolution of the aggregated index for the North WAP suggests a system that was functioning as a herbivorous–multivorous food web, which over the 12 yr evolved toward a microbial food web. Over the 12 yr period, the South WAP started as a strongly microbial system (maybe as a result of decreased flow through krill and the low sea-ice years in previous winters, Figs. 4 & 9), then oscillated between a herbivorous and microbial food web; on average, the South WAP was a multivorous food web. In general, neither region was herbivorous, and both had important microbial elements.

Penguin–krill sensitivity experiments

For all years, both in the North and South, the nutritional or energy needs of Adélie penguins were met at a level slightly higher than their minimal constraints value (i.e. the minimum amount of intake needed to satisfy basal metabolism). For example, the minimum bound < solution value < maximum bound for flow of krill to penguin was $0.00367 < 0.00375 < 0.0042 \text{ mmol C m}^{-2} \text{ d}^{-1}$ in the North and $0.0413 < 0.0422 < 0.0472 \text{ mmol C m}^{-2} \text{ d}^{-1}$ in the South WAP for average constraints. On a side note, the parsimonious solution value for penguin ingestion was close to the maximal constraint in both North and South (results not shown). Because the model indicates that the Adélie penguins in the North WAP were not starved, it raises the question of whether the food web was capable of supporting a larger colony. In 1975, the Adélie population at Palmer Station was

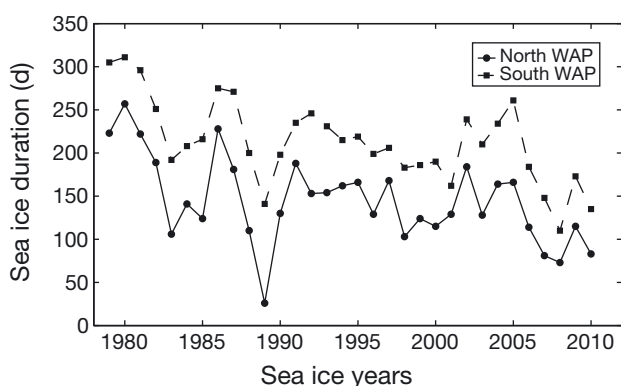

Fig. 9. Sea-ice duration at Anvers Island (North western Antarctic Peninsula, WAP: solid line with dots) and Avian Island (South WAP: dashed line with squares), derived from satellite microwave data (data courtesy S. Stammerjohn). Note that the sea-ice year runs from its annual advance in April to May until the following year: a year 'Y' for sea ice will correspond to the year 'Y+1' for summer (January) observations and inverse model results

estimated to be 15 202 breeding pairs, a value we used to constrain a larger population in a sensitivity experiment. The state of the food web, especially primary production, varies from year to year, so instead of picking a year in which to implement the modified Adélie constraints, we used the North WAP average food web. Estimated Adélie ingestion of krill for the 1975 population was higher than the minimum constraints ($0.0167 < 0.0171 < 0.0191 \text{ mmol C m}^{-2} \text{ d}^{-1}$), indicating that the current food web could support more than the minimum daily ration at the higher population constraint. The factor of 5 increase in Adélie population had little impact on other flows within the food web; any changes in flows were less than 0.1 % of the 'original' value.

However, Adélie penguins are not the only krill predators in WAP waters, and in 2010, Adélie penguins accounted for just 50 % of the total penguin population at Palmer Station (Ducklow et al. 2012; W. Fraser unpubl. data; <http://oceaninformatics.ucsd.edu/data-zoo/data/pallter/datasets>). The other 50 % is comprised of chinstrap and gentoo penguins that have appeared since the 1990s. Baleen whales and crabeater seals also use krill as their main food source, and krill are an important part of fur seal diets as well. The addition of other krill predators in the inverse model would impact flow to penguins as well as other flows through the food web, possibly inducing food starvation for adult Adélie penguins and changing the whole food-web state. To ascertain the effect of additional krill predators on penguin ingestion and krill flows, we used the inverse model with average constraints for the North and added an external compartment for other top predators. The other top predator compartment, as an external compartment, is not subject to mass balance, and the only inflow was from krill and equal to a fraction of average krill biomass, equivalent to cropping out part of the krill biomass each day. The cropping factor was no greater than natural loss and predation by Adélie penguins combined. The cropping ranged from 0 to 5 % d^{-1} of the average krill biomass in the North WAP, in 0.5 % d^{-1} increments. When the new solutions are computed, flows through krill readjust to the increased demand. Changes in flows through krill were less than 7 % of the initial value. Mostly krill outflows (respiration, export, and DOC) were reduced to account for the additional predation, with no increase in krill ingestion. Flows through other compartments were not affected, except for a decrease in bacteria ingestion by 20 % (from 0.17 to 0.13 $\text{mmol C m}^{-2} \text{ d}^{-1}$), which can be linked to an increase in phytoplankton respiration and export to fit the new constraints, as well as a

reduced pool of DOC. This result and the previous one (size of the Adélie population) suggest that the actual krill stock can sustain the Adélie penguin population as well as additional krill predators. In addition, the model food web has sufficient flexibility to accommodate the increased demand within the bounds of the constraints we set.

Salp sensitivity experiment

Over the years, increasing numbers of salps have been captured in trawls in the WAP shelf region (Fig. 1e; trend continues in 2009–2012; D. Steinberg pers. obs.). Salps are efficient grazers of small phytoplankton, bacteria and microzooplankton, which they repackage into rapidly sinking fecal pellets that are exported out of the euphotic zone (Gleiber et al. 2012). With around 40% of ingested nitrogen and 49% of ingested carbon excreted (Pakhomov et al. 2002), salps also increase the pool of dissolved organic matter available for bacterial production. The WAP average salp abundances over the 12 yr period were 2.8 and 1.0 ind. m⁻² in the North and South, respectively. To fully evaluate the impact of salps on the WAP food web, a sensitivity experiment was conducted by setting both North and South WAP abundances to a high value (56 ind. m⁻², observed in the Ross Sea; Pakhomov et al. 2006). In both the North and South, the flow of carbon through salps increased in proportion to the salp biomass increase, and as a result, flows through other compartments were reduced to maintain mass balance. For example, the flows from detritus to krill and microzooplankton were increased to compensate for the decrease in the flow from other resources. Additionally, salps had similar effects on the pathways for carbon in the North and South WAP. The presence of salps increased the transfer of carbon through the food web (Ft) and the export (Et) while reducing the respiration (Rt, less carbon circulating in the microbial loop). The effect was negligible in the South WAP and the food web remained multivorous. In the North WAP, export and food-web transfer were doubled, changing the food web from a microbial to a multivorous food web. These results showed that the system could sustain both salps and krill, but increased presence of salps could change the carbon pathways and further alter the system.

Mesozooplankton (copepods) sensitivity experiment

Copepods can be a significant component of the Antarctic food web, at times even exceeding krill in terms of biomass and grazing pressure. We included copepods in the inverse model food web as a generic omnivore, i.e. grazing on phytoplankton (large and small), microzooplankton, and detritus. Loss terms are respiration, egestion (to detritus and export), excretion (to DOC), and loss due to grazing by krill and, in the South WAP, silverfish (see Table 5 for constraint details). To help constrain the flows, we used available copepod biomass (>750 µm, thus including mostly larger species) from the 2009 to 2011 PAL-LTER austral summer cruises; the highest biomass recorded was used for the North and South WAP, respectively.

In both the North and South WAP, the inverse model results indicate that the presence of copepods decreases the flow of carbon from small phytoplankton to microzooplankton and from microzooplankton to krill. These flows of carbon are redirected through copepods, i.e. small phytoplankton to copepods, microzooplankton to copepods, and copepods to krill. Flows through bacteria, salps, and Adélie penguins are slightly impacted (less than 15% change in flow value). These changes are expected with the inclusion of a new compartment and the resulting new flows.

The impact on network indices is a change of 0.03 and 0.04 in the North and South WAP, respectively, for the values of Rt/Pt, Ft/Pt, and Et/Pt. In the North, Rt/Pt decreased while Ft/Pt and Et/Pt increased, which means a slight increase in food web transport and subsequent export over the recycling processes. In the South, Rt/Pt increased while Ft/Pt and Et/Pt decreased, describing a slight increase in recycling processes over food-web transfer. However, in both cases, the change in network indices does not indi-

Table 5. Constraints on copepods flows for the inverse model. DOC: dissolved organic carbon

| Rate | Lower bound | Higher bound | Source |
|----------------|--|--|---|
| Ingestion rate | 0.82 µg C ind. ⁻¹ d ⁻¹ | 45 µg C ind. ⁻¹ d ⁻¹ | Li et al. (2001) Dubischar & Bathmann (1997) |
| Respiration | 4.9 µg C ind. ⁻¹ d ⁻¹ | 100% ingestion | Calbet et al. (2006) |
| To DOC | 10% ingestion | 90% ingestion | – |
| To detritus | 10% ingestion | 90% ingestion | – |
| To export | 10% ingestion | 90% ingestion | – |

cate a change in the dominant pathway and system state with the inclusion of copepods in the food web.

DISCUSSION

State of the system

Our inverse model results indicated that the WAP system is not dominated by the diatom–krill–apex predator food chain, primarily because microzooplankton ingested double the amount ingested by krill, and carbon flow through bacteria is equivalent to ~75% of the carbon ingested by krill. Microzooplankton grazing on both the large and small fraction of phytoplankton, as well as on bacteria, was an effective link between krill and smaller organisms. In fact, krill gut contents can contain from 20 to 80% microzooplankton (gut volume; Perissinotto et al. 2000), and information generated by the inverse model suggests that microzooplankton could make up from 10 to 70% of total carbon ingested by krill (37% in the South, 56% in the North, on average). The amount of microzooplankton ingested by krill varied with the fraction of large phytoplankton available; krill ingest more microzooplankton to cover their metabolic needs when there are fewer large phytoplankton (Bernard et al. 2012). The importance of microzooplankton as a link between smaller organisms and krill shows that the South WAP food web can be described as a multivorous system, oscillating between a fully herbivorous food web with krill as the dominant grazer, and a microbial food web where microzooplankton grazing and bacterial production are more important. However, South WAP bacterial ingestion and respiration rates did not increase with time, suggesting that the system is not evolving toward a more microbially-dominated food web.

Based on the inverse model-derived ecosystem index values, the North WAP food web has apparently transitioned from a multivorous to a microbial food web over time. Microbial processes became increasingly important with the increase in small phytoplankton primary production and resultant decrease in flow through krill. This is illustrated by bacterial ingestion and respiration increasing from 5 to 15% of primary production over the 1995 to 2006 period, and the inverse correlation between krill and microzooplankton ingestion and respiration (Fig. 4). While there was considerable interannual variation in both krill and microbial (bacteria and microzooplankton) flows in the South WAP, there were no long-term directional trends.

According to our initial hypothesis, the North WAP was once in the same state of multivorous equilibrium as the South WAP is now. If so, a transition occurred prior to the sampling period considered here. It remains to be explored whether the transition from one state to the other was progressive, or happened abruptly when the system reached an unknown tipping point, like the decline of the Adélie population (Scheffer et al. 2001, Bestelmeyer et al. 2011). Even though it is possible that the South WAP is now in the same state as the North WAP was in 2 decades ago, we cannot know its original state or whether it has fully settled into a new state. South WAP variability (Figs. 1 & 5–9) could reflect several scenarios: (1) the oscillating state that the North WAP was in 2 decades ago; (2) the relaxation from an unknown state into a new state; or (3) an ongoing transition toward the same microbial-dominated state as the North WAP, as the effects of climate change become more pronounced and sea-ice coverage/duration continues to decline. The transition observed in 1995 to 2000 from a microbial to multivorous food web supports both hypotheses 2 and 3 because the South WAP could be settling into a multivorous food web state, or recovering from a disturbance (e.g. low sea-ice years and decline of sea-ice duration in the 1990s, Fig. 9) that had temporarily resulted in a microbial system in 1995 or earlier.

The difference between the North and South WAP is also linked to bacterial dependence on the amount of available DOC. In both the North and South, the main source of DOC is phytoplankton exudation, from both the large and small size fractions. Grazing of large phytoplankton by krill reduces the amount of DOC that can be exuded by this phytoplankton size fraction, leaving small phytoplankton as the major source of exuded DOC for bacteria. In the South, where the ratio of large to small phytoplankton averages 0.49, there was little fluctuation in the amount of DOC available to bacteria. In contrast, the percentage of primary production due to large phytoplankton in the North decreased with time, and the DOC pool increased with small phytoplankton predominance (greater inflow from the small phytoplankton to the DOC); as a result, DOC uptake by bacteria increased in the North as well. Rates of DOC release by sloppy feeding are higher for grazing on larger phytoplankton (Møller 2004). Thus, when the phytoplankton assemblage is dominated by the larger size fraction, sloppy feeding by krill is an additional source of DOC (up to 3% of the grazed phytoplankton carbon, 12% by excretion; see Saba et al. 2011 for copepods). This effect is not accounted for in the inverse model constraints.

When describing pathways and network indices, Legendre & Rassoulzadegan (1996) assumed that the fate of primary production is linked primarily to the phytoplankton size fraction: the more smaller phytoplankton are present, the more the system turns into a microbial food web. However, they did not take the fate of DOC into account. In our analysis, carbon entering the DOC pool is considered as part of the recycling pathway (R_t) along with respiration. In the solutions, DOC export is as important as particle (detritus) export, but DOC export is not included in E_t because only particles are taken into account for this index. Seasonal observations of DOC at Palmer Station (Years 2002 to 2012) show repeated peaks with an amplitude of approximately 20 mmol C m^{-3} above the background concentration that can last about 2 wk. This indicates a build-up and subsequent use of the DOC pool, or lateral or vertical advection. The average flow of exported DOC in the inverse model is $4.8 \text{ mmol C m}^{-2} \text{ d}^{-1}$, equivalent to the build-up of about 1 mmol C m^{-3} in the same time period as the observed DOC variations, much smaller than indicated by Palmer Station data, which may be influenced by local-scale variability. Obviously, the mass-balance in the inverse model forces any accumulated DOC to be subsumed into export, neglecting the possibility of a non-steady state of DOC and large fluctuations in the pool.

If the DOC is truly advected away, it would more appropriately be accounted for as a part of food web transport (F_t) or export of unused phytoplankton carbon, changing the dominant pathway toward a more multivorous/herbivorous fate of primary production. On the other hand, if it is used by bacteria and respired locally, it is part of the recycling pathway (R_t) and the dominant pathway for the fate of primary production is microbial. This suggests that the microbial state of the food web (North or South) may be slightly overestimated by the network indices. The trends towards an increase of microbial processes with time are still valid. Resolving these questions requires a better understanding and additional data on the fate of DOC (e.g. use by bacteria, accumulation, transport) and how its source (e.g. phytoplankton, krill) impacts its fate (e.g. bacterial preference for DOC from small phytoplankton).

Finally, while our inverse model effort focused on ecosystem dynamics, physical forcing and dynamics should not be neglected. Melting of sea ice increases stratification, favoring the start of the productive season. Sea-ice duration and extent in WAP waters have decreased over the past several decades (Stammerjohn et al. 2008). Changes in sea-ice conditions cou-

pled to warming have favored more sub-polar organisms, including salps, that are not ice dependent, in contrast to krill and Adélie penguins (Ducklow et al. 2012). The general consensus is that there is little co-occurrence of salps and krill; the system will tend to accommodate either one or the other (Pakhomov et al. 2002). Recent PAL-LTER data may necessitate a reevaluation of this generalization. The increase in salp abundance, as well as the results of the salp sensitivity experiment, suggests that other parameters are influencing the separation between krill and salps. The likely factor is the dominant size class of phytoplankton: large phytoplankton cells (favored by krill) clog the filtering apparatus of salps, leading to starvation and death (Perissinotto & Pakhomov 1998). If phytoplankton populations become dominated by small phytoplankton, it will reduce the importance of the diatom–krill food chain and favor salps, changing the food web further (e.g. increased but more sporadic export, Gleiber et al. 2012; weakening of apex predators, Loeb et al. 1997).

Adélie penguins

The inverse model results suggest that a food-web structure consistent with current observations can provide enough krill to sustain penguin metabolic requirements as constrained, either at current or historic population levels. Addition of other krill predators to the inverse model, as simulated with the cropping of krill by other top predators, would still not prevent Adélies from obtaining enough krill to sustain themselves. It is important to remember that these experiments only address an average state, in which krill were uniformly available to their predators throughout the study period, and do not, for example, consider changes in the spatial distribution or availability of krill within the local foraging range at each location, as might have occurred with changes in the seasonality and duration of sea-ice cover, and other region-specific ecosystem changes (Stammerjohn et al. 2008, Montes-Hugo et al. 2009). Factors other than summer food supplies and daily rations that also affect Adélies in the breeding and growing season are beyond the scope of this bioenergetics-based food-web model.

The inverse model results indicating sufficient krill biomass to support the Adélie penguin colony and additional predators are supported by krill biomass data and census of krill predators. The krill standing stock over the northern Adélie colony foraging area, and available to the Adélies, is $2.25 \times 10^6 \text{ kmol C}$

(from data used to constrain the inverse model, 12 yr average). A population of 100 crabeater seals would consume approximately $5.7 \text{ kmol C d}^{-1}$ (Priddle et al. 1998). The number of seals that depend on krill as part or all of their diet in the area surrounding Palmer Station is on average 200 individuals (W. Fraser unpubl. data), so the addition of other top predators would not increase krill predation enough to change flows through the inverse model. The daily consumption by seals is 1 order of magnitude less than the daily consumption by Adélie penguins ($69.2 \text{ kmol C d}^{-1}$). The estimated whale population on the entire WAP in 2000 consumed a minimum of $1.78 \times 10^6 \text{ kmol C d}^{-1}$ (Reilly et al. 2004). If all of these whales were concentrated in the foraging area of the northern Adélie penguin colony, the population could remove about 80% of the krill biomass in a single day. This is of course an extreme example, but it indicates how episodic predation events could impact our data analysis.

Copepods

As with the other top-predator compartment, we addressed copepods with a sensitivity analysis. Copepods can be the dominant phytoplankton grazer in areas where, or at times when, krill are scarce, and copepod fecal pellets can occasionally contribute significantly to export flux (Gleiber et al. 2012). However, in austral summer, krill are the dominant grazers especially in water influenced by sea ice (Bernard et al. 2012, Steinberg et al. 2012), and krill fecal pellets dominate export flux (Gleiber et al. 2012). The sensitivity analysis showed how inclusion of copepods changed flows through the WAP pelagic food web. While a significant amount of carbon is redirected through copepods, it did not significantly impact the value of network indices and the resulting dominant pathway in either the North or South WAP. However, in the changing system that is the WAP, their role and that of other mesozooplankton groups should be considered (Steinberg et al. 2012).

Caveats for model interpretation

Several caveats should be considered in interpreting the inverse model results. One is the patchiness of the environment, especially of krill distribution. The second is the quality of krill as prey in terms of lipid content (energy reserves), which is related to the dynamics of the krill stocks along the WAP (iso-

lated population or inflow from other parts of the Southern Ocean).

The patchy prey distribution cannot be adequately addressed in this model. By averaging the krill biomass over the penguin foraging area, we assumed a homogeneous distribution of krill and ignored foraging cost and time. Energy expenditure for foraging increases the daily portion of krill needed by adult Adélies. Trivelpiece et al. (2011) concluded that the observed decline in some penguin populations (including the one at Palmer Station) is due to a decline in krill biomass. However, at Palmer Station, according to our results, krill are sufficient to sustain the Adélie population even though Adélies have declined in recent decades. As such, the problem may be one of availability of krill to the penguins rather than one of simple total krill quantity. The high spatial variability of krill (not taken into account in our work) and the dependence of Adélies on sea ice could combine to prevent the penguins from having access to enough krill to support themselves and their chicks. By this we mean that krill swarms could occur out of the foraging area of the Palmer region, or that Adélies or the krill swarms present in the foraging area could be too low in density. As a result, even though there apparently are enough krill in the WAP area to meet the metabolic needs of Adélies, the energy Adélies must expend in search of krill could be too high. This is supported by Atkinson et al. (2008), who pointed out that only 13% of the krill population can be found in waters populated by krill predators.

Additionally, there is the issue of the North WAP krill stock origin and state. Model constraints do not account for krill growth, reproduction, and reserve building. It is possible that primary production is sufficient to support the krill stock, that is to maintain the population, but no more than that. Consequently, krill may not have the opportunity to build their internal energy reserves and are thus a poor-quality prey (i.e. low energetic value, low lipid content). If so, the decline in Adélies would not only be due to the lack of prey availability but also due to low prey quality. Low prey quality could also explain why the Adélie chicks are not reaching an appropriate fledgling weight in the North WAP compared to the South WAP (Fraser & Hofmann 2003, Chapman et al. 2010), with the possibility that food limitation is occurring at the chick stage, not the adult stage, as assumed. This concern is somewhat addressed by the fact that there is a high flow from krill to export; the model did not include a capability for storage of reserves, and consequently carbon that could have gone into reserves

is instead exported to preserve the mass-balance. Carbon that is not attributed to an outflow goes to the export; thus, in the model at least krill have the available resources to build reserves, and krill quality likely is not the only factor causing penguin starvation. The Antarctic silverfish, another important item in the Adélie diet, is now functionally extinct from the northern area around Palmer Station (W. Fraser unpubl. data). Consequently, the absence (presence) of Antarctic silverfish in the diet of Adélies from the colony in the North (South) is more likely to affect chick survival.

Another important factor influencing these findings is seasonality. Due to the sampling scheme and the inherent nature of the inverse model, we have been working with a succession of ‘snapshots’ of the food web during the austral summer. This succession of ‘snapshots’ is adequate for checking whether the system changed through time but not to assess seasonal variation. In winter and early spring, the system is different, with sea ice playing an important role in shaping the physics and the biology. Sea ice has been declining and retreating earlier in the season over the past years (Fig. 9; Stammerjohn et al. 2008). Consequently, although we only observed and studied the WAP during the summer, the observed summertime changes along with the results of the present study also reflect the importance of the winter–early spring period and its changes in recent decades. Other seasons remain much less well studied than the summer period considered here and should be considered in future work

CONCLUSION

The WAP pelagic ecosystem is in transition or in different states along a north–south gradient. The North WAP food web, in its current state, can sustain the colony of Adélies at its current or historic levels, even competing with other krill predators such as crabeater seals or baleen whales. Considering the diet differences between the North and South Adélie colonies (i.e. absence/presence of fish), the reason for the decline of the northern colony may be in the quality and not the quantity of the food supply (Chapman et al. 2010). Overwintering factors and other non-food related factors that influence breeding success (e.g. early season snowfall, glacial meltwater; Chapman et al. 2011) must also be considered.

Lastly, predominance of the microbial processes or the diatom–krill food chain is of importance in how we visualize and approach the Antarctic coastal eco-

system. For example, Huntley et al. (1991) asserted that 20 to 25 % of the primary production in Antarctic coastal water is respired by top predators. This conclusion was reached through the use of a model where 80 % of the primary production is consumed by zooplankton, not including microzooplankton. However, both observations and our inverse model results point out that a maximum of 10 % of the primary production is channeled through krill or other grazers (e.g. copepods and pteropods; the exception being salp blooms with considerably higher grazing impact on primary production, Bernard et al. 2012). Since krill are among the primary prey items for top predators, and of commercial interest, overestimating their grazing impact could have far reaching consequences, as could the transition from a krill-dominated ecosystem state to a more microbial-based system.

Acknowledgements. We acknowledge support from the National Science Foundation, Office of Polar Programs, Award 0823101 (Antarctic Organisms and Ecosystems Program) to Palmer LTER. We are grateful to J. Peloquin for analyzing the HPLC data with ChemTax.

LITERATURE CITED

- Alcaraz M, Saiz E, Fernandez J, Trepal I, Figueiras F, Calbet A, Bautista B (1998) Antarctic zooplankton metabolism: carbon requirements and ammonium excretion of salps and crustacean zooplankton in the vicinity of the Bransfield strait during January 1994. *J Mar Syst* 17:347–359
- Anadon R, Alvarez-Marques F, Fernandez E, Varela M, Zapate M, Gasol JM, Vaque D (2002) Vertical biogenic particle flux during austral summer in the Antarctic Peninsula area. *Deep-Sea Res II* 49:883–901
- Arrigo K, Worthen D, Schnell A, Lizotte M (1998) Primary production in southern ocean waters. *J Geophys Res C Oceans* 103:15587–15600
- Atkinson A, Siegel V, Pakhomov EA, Rothery P (2004) Long-term decline in krill stock and increase in salps within the Southern Ocean. *Nature* 432:100–103
- Atkinson A, Siegel V, Pakhomov EA, Rothery P and others (2008) Oceanic circumpolar habitats of Antarctic krill. *Mar Ecol Prog Ser* 362:1–23
- Bernard KS, Steinberg DK, Schofield OME (2012) Summer-time grazing impact of the dominant macrozooplankton off the Western Antarctic Peninsula. *Deep-Sea Res I* 62: 111–122
- Bestelmeyer BT, Ellison AM, Fraser WR, Gorman KB and others (2011) Analysis of abrupt transitions in ecological systems. *Ecosystems* 2:art129
- Calbet A, Atienza D, Broglio E, Alcaraz M, Vaqué D (2006) Trophic ecology of *Calanoides acutus* in Gerlache Strait and Bellingshausen Sea waters (Antarctica, December 2002) *Polar Biol* 29:510–518
- Chapman EW, Hofmann EE, Patterson DL, Fraser WR (2010) The effects of variability in Antarctic krill (*Euphausia superba*) spawning behavior and sex/maturity stage dis-

- tribution on Adélie penguin (*Pygoscelis adeliae*) chick growth: a modeling study. *Deep-Sea Res II* 57:543–558
- Chapman EW, Hofmann EE, Patterson DL, Ribic CA, Fraser WR (2011) Marine and terrestrial factors affecting Adélie penguin *Pygoscelis adeliae* chick growth and recruitment off the western Antarctic Peninsula. *Mar Ecol Prog Ser* 436:273–289
- Chappell MA, Shoemaker VH, Janes DN, Maloney SK, Bucher TL (1993) Energetics of foraging in breeding Adélie penguins. *Ecology* 74:2450–2461
- Daniels RM, Richardson TL, Ducklow HW (2006) Food web structure and biogeochemical processes during oceanic phytoplankton blooms: an inverse model analysis. *Deep-Sea Res II* 53:532–554
- Dubishar CD, Bathmann UV (1997) Grazing impact of copepods and salps on phytoplankton in the Atlantic sector of the Southern Ocean. *Deep-Sea Res II* 44:415–433
- Ducklow HW, Fraser W, Karl DM, Quetin LB and others (2006) Water-column processes in the west Antarctic Peninsula and the Ross Sea: interannual variations and food web structure. *Deep-Sea Res II* 53:834–852
- Ducklow HW, Baker K, Martinson DG, Quetin LB and others (2007) Marine pelagic ecosystems: the west Antarctic Peninsula. *Philos Trans R Soc Lond B Biol Sci* 362:67–94
- Ducklow HW, Clarke A, Dickhut R, Doney SC and others (2012) The marine ecosystem of the West Antarctic Peninsula. In: Rogers A, Johnston N, Clarke A, Murphy E (eds) *Antarctica: an extreme environment in a changing world*. Blackwell, London, p 121–159
- El-Sayed S (1988) Productivity of the southern ocean: a closer look. *Comp Biochem Physiol B Comp Biochem* 90: 489–498
- Eppley RW, Peterson BJ (1979) Particulate organic matter flux and planktonic new production in the deep ocean. *Nature* 282:677–680
- Fraser WR, Hofmann EE (2003) A predator's perspective on causal links between climate change, physical forcing and ecosystem response. *Mar Ecol Prog Ser* 265:1–15
- Garzio LM, Steinberg DK (2013) Microzooplankton community structure along the Western Antarctic Peninsula. *Deep-Sea Res I* 77:36–49
- Garzio LM, Steinberg DK, Erickson M, Ducklow HW (2013) Microzooplankton grazing along the Western Antarctic Peninsula. *Aquat Microb Ecol* 70:215–232
- Gleiber MR, Steinberg DK, Ducklow HW (2012) Time series of vertical flux of zooplankton fecal pellets on the continental shelf of the western Antarctic Peninsula. *Mar Ecol Prog Ser* 471:23–36
- Glover DM, Jenkins WJ, Doney SC (2011) *Modeling methods for marine science*. Cambridge University Press, Cambridge
- Hart T (1934) On the phytoplankton of the south-west Atlantic and the Bellingshausen Sea, 1929–1931. *Discov Rep* 8:1–268
- Hewes C, Sakshaug E, Holm-Hansen O (1985) Alternative pathways at lower trophic levels in the Antarctic food web. In: Siegfried W, Condy P, Laws R (eds) *Antarctic nutrient cycles and food webs*. Springer, Berlin, p 277–283
- Huntley ME, Sykes PF, Marin V (1989) Biometry and trophodynamics of *Salpa thompsoni* Foxton (Tunicata: Thaliacea) near the Antarctic Peninsula in austral summer, 1983–1984. *Polar Biol* 10:59–70
- Huntley ME, Lopez MDG, Karl DM (1991) Top predators in the southern ocean: a major leak in the biological carbon pump. *Science* 253:64–66
- Iguchi N, Ikeda T (2004) Metabolism and elemental composition of aggregate and solitary forms of *Salpa thompsoni* (Tunicata: Thaliacea) in waters off the Antarctic Peninsula during austral summer 1999. *J Plankton Res* 26: 1025–1037
- Ikeda T, Mitchell AW (1982) Oxygen uptake, ammonia excretion and phosphate excretion by krill and other Antarctic zooplankton in relation to their body size and chemical composition. *Mar Biol* 71:283–298
- Le Fevre J, Legendre L, Rivkin RB (1998) Fluxes of biogenic carbon in the southern ocean; roles of large microphagous zooplankton. *J Mar Syst* 17:325–345
- Legendre L, Rassoulzadegan F (1996) Food-web mediated export of biogenic carbon in oceans: hydrodynamic control. *Mar Ecol Prog Ser* 145:179–193
- Li C, Sun S, Zhang G, Ji P (2001) Summer feeding activities of zooplankton in Prydz Bay, Antarctica. *Polar Biol* 24: 892–900
- Loeb V, Siegel V, Holm-Hansen O, Hewitt R, Fraser W, Trivelpiece W, Trivelpiece S (1997) Effects of sea-ice extent and krill or salp dominance on the Antarctic food web. *Nature* 387:897–900
- Martinson D, Stammerjohn SE, Iannuzzi R, Smith R, Vernet M (2008) Western Antarctic Peninsula physical oceanography and spatio-temporal variability. *Deep-Sea Res II* 55:1964–1987
- McWhinnie MA, Denys CJ (1980) The high importance of the lowly krill. *Nat Hist* 89:66–73
- Moline MA, Karnovsky NJ, Brown Z, Divoky GJ and others (2008) High latitude changes in ice dynamics and their impact on polar marine ecosystems. *Ann NY Acad Sci* 1134:267–319
- Møller EF (2004) Sloppy feeding in marine copepods: prey-size-dependent production of dissolved organic carbon. *J Plankton Res* 27:27–35
- Moloney CL, Field JG (1989) General allometric equations for rates of nutrient uptake, ingestion, and respiration in plankton organisms. *Limnol Oceanogr* 34:1290–1299
- Montes-Hugo M, Doney SC, Ducklow HW, Fraser W, Martinson D, Stammerjohn SE, Schofield O (2009) Recent changes in phytoplankton communities associated with rapid regional climate change along the western Antarctic Peninsula. *Science* 323:1470–1473
- Morris DJ, Watkins JL, Ricketts C, Buchholz F, Priddle J (1988) An assessment of the merits of length and weight measurements of Antarctic krill *Euphausia superba*. *Br Antarct Surv Bull* 79:27–50
- Pakhomov E, Froneman P, Perissinotto R (2002) Salp/krill interactions in the southern ocean: spatial segregation and implications for the carbon flux. *Deep-Sea Res II* 49: 1881–1907
- Pakhomov E, Dubishar C, Strass V, Brichta M, Bathmann U (2006) The tunicate *Salpa thompsoni* ecology in the Southern Ocean. I. Distribution, biomass, demography and feeding ecophysiology. *Mar Biol* 149:609–623
- Perissinotto R, Pakhomov EA (1998) The trophic role of the tunicate *Salpa thompsoni* in the Antarctic marine ecosystem. *J Mar Syst* 17:361–374
- Perissinotto R, Pakhomov EA, McQuaid CD, Froneman PW (1997) *In situ* grazing rates and daily ration of Antarctic krill *Euphausia superba* feeding on phytoplankton at the Antarctic Polar Front and the Marginal Ice Zone. *Mar Ecol Prog Ser* 160:77–91
- Perissinotto R, Gurney L, Pakhomov EA (2000) Contribution of heterotrophic material to diet and energy budget

- of Antarctic krill, *Euphausia superba*. Mar Biol 136: 129–135
- Phillips B, Kremer P, Madin LP (2009) Defecation by *Salpa thompsoni* and its contribution to vertical flux in the southern ocean. Mar Biol 156:455–467
- Pridde J, Boyd I, Whitehouse M, Murphy E, Croxall J (1998) Estimates of Southern Ocean primary production—constraints from predator carbon demand and nutrient drawdown. J Mar Syst 17:275–288
- Reilly S, Hedley S, Borberg J, Hewitt R, Thiele D, Watkins J, Naganobu M (2004) Biomass and energy transfer to baleen whales in the South Atlantic sector of the Southern Ocean. Deep-Sea Res II 51:1397–1409
- Ross RM, Quetin LB, Haberman KL (1998) Interannual and seasonal variability in short-term grazing impact of *Euphausia superba* in nearshore and offshore waters west of the Antarctic Peninsula. J Mar Syst 17:261–273
- Saba GK, Steinberg DK, Bronk DA, Place AR (2011) The relative importance of sloppy feeding, excretion, and fecal pellet leaching in the release of dissolved carbon and nitrogen by *Acartia tonsa* copepods. J Exp Mar Biol Ecol 404:47–56
- Scheffer M, Carpenter S, Foley JA, Folke C, Walker B (2001) Catastrophic shifts in ecosystems. Nature 413:591–596
- Shreeve RS, Tarling GA, Atkinson A, Ward P, Goss C, Watkins J (2005) Relative production of *Calanoides acutus* (Copepoda: Calanoida) and *Euphausia superba* (Antarctic krill) at South Georgia, and its implications at wider scales. Mar Ecol Prog Ser 298:229–239
- Siegel V (1992) Assessment of the krill (*Euphausia superba*) spawning stock off the Antarctic Peninsula. Arch Fisch Wiss 41:101–130
- Smith R, Stammerjohn S (2001) Variations of surface air temperature and sea ice extent in the Western Antarctic Peninsula (WAP) region. Ann Glaciol 33:493–500
- Smith R, Dierssen H, Vernet M (1996) Phytoplankton biomass and productivity in the western Antarctic Peninsula region. In: Ross R, Hofmann E, Quetin L (eds) Foundation for ecological research west of the Antarctic Peninsula. American Geophysical Union, Washington, DC, p 333–356
- Smith R, Baker KS, Byers M, Stammerjohn SE (1998) Primary productivity of the Palmer Long Term Ecological Research Area and the Southern Ocean. J Mar Syst 17: 245–259
- Smith WO Jr, Gordon LI (1997) Hyperproductivity of the Ross Sea (Antarctica) polynya during austral spring. Geophys Res Lett 24:233–236, doi:10.1029/96GL03926
- Soetaert K, Van den Meersche K, Van Oevelen D (2009) Limsolve: solving linear inverse models. R package version 1.5. www.jstatsoft.org/v30/c01
- Stammerjohn SE, Martinson DG, Smith R, Iannuzzi R (2008) Sea ice in the western Antarctic Peninsula region: spatio-temporal variability from ecological and climate change perspectives. Deep-Sea Res II 55:2041–2058
- Steinberg DK, Martinson DG, Costa DP (2012) Two decades of pelagic ecology of the Western Antarctic Peninsula. Oceanography 25:56–67
- Stukel MR, Landry MR (2010) Contribution of picophytoplankton to carbon export in the equatorial Pacific: a reassessment of food web flux inferences from inverse models. Limnol Oceanogr 55:2669–2685
- Stukel MR, Landry MR, Ohman MD, Goericke R, Samo T, Benitez-Nelson CR (2012) Do inverse ecosystem models accurately reconstruct plankton trophic flows? Comparing two solution methods using field data from the California current. J Mar Syst 91:20–33
- Trivelpiece WZ, Hinke JT, Miller AK, Reiss CS, Trivelpiece SG (2011) Variability in krill biomass links harvesting and climate to penguin population changes in Antarctica. Proc Natl Acad Sci USA 108:7625–7628
- Valiela I (1995) Marine ecological processes. Springer, New York, NY
- Van den Meersche K, Soetaert K, Van Oevelen D (2009) Xsample(): an R function for sampling linear inverse problems. J Stat Softw 30:code snippet 1
- Vaughan D, Marshall G, Connolley W, Parkinson C, Mulvaney R (2003) Recent rapid regional climate warming on the Antarctic Peninsula. Clim Change 60:243–274
- Vernet M, Martinson D, Iannuzzi R, Stammerjohn S and others (2008) Primary production within the sea-ice zone west of the Antarctic Peninsula. I. Sea ice, summer mixed layer, and irradiance. Deep-Sea Res II 55:2068–2085
- Waters KJ, Smith RC (1992) Palmer LTER: a sampling grid for the Palmer LTER program. Antarct J US 27:236–239
- Wright SW, Van den Enden RL (2000) Phytoplankton community structure and stocks in the East Antarctic marginal ice zone (BROKE survey, January–March 1996) determined by CHEMTAX analysis of HPLC pigment signatures. Deep-Sea Res II 47:2363–2400

Editorial responsibility: Matthias Seaman, Oldendorf/Luhe, Germany

Submitted: October 5, 2012; Accepted: August 23, 2013
 Proofs received from author(s): October 21, 2013